

R Reliance

RIGID PVC / uPVC PROFILES FOR ARCHITECTURAL ALUMINIUM SYSTEMS

PVC without the addition of plasticizer is known as Rigid PVC or uPVC. Thanks to technological advancement, it now possesses excellent weather-ability and is high resistant to ageing. Its outstanding thermal resistant properties make it an excellent choice in Architectural System Applications.

Reliance Industries LLC manufactures Rigid PVC/uPVC Profiles in different colors and takes pride in having a wide array of design possibilities. It is a product of choice for Architectural Aluminum applications with excellent weather resistant and uniform thermal resistance.



ADVANTAGES - RIGID PVC / uPVC PROFILES

- Excellent Mechanical Properties
- Excellent Impact Resistance
- Excellent UV and Weather Resistance
- Excellent Flame Retardancy
- Smooth and Homogenous Surface Finish
- Excellent Process-ability
- Variety of Colors
- Green Material (100% Lead Free)
- LEEDS Compliance

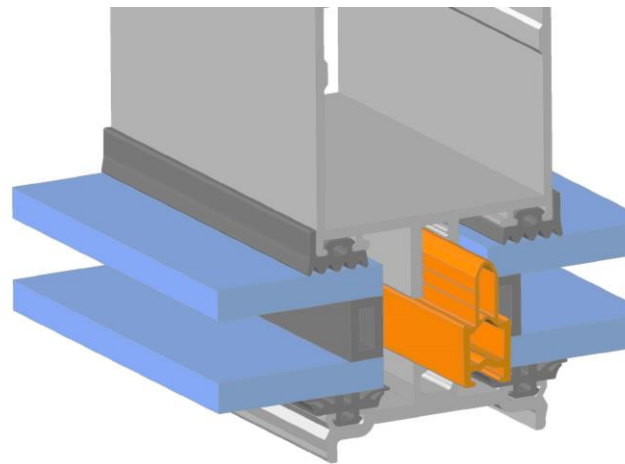
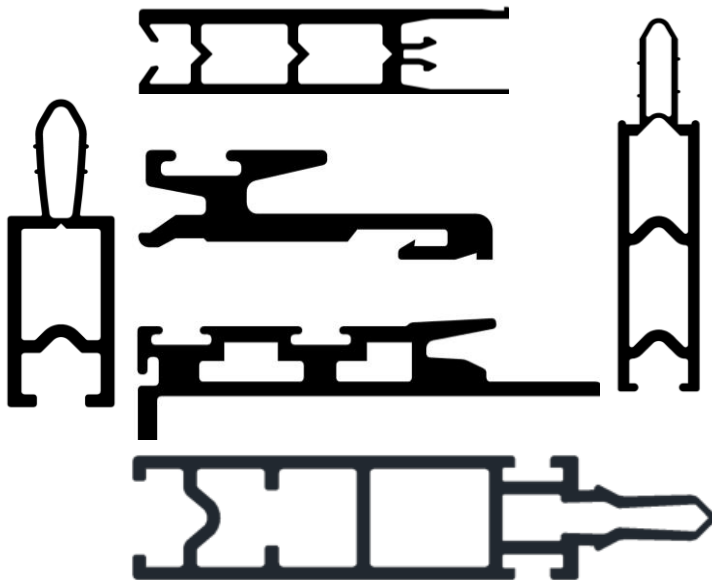



Reliance

**RIGID PVC / uPVC PROFILES
FOR ARCHITECTURAL ALUMINIUM SYSTEMS**

TECHNICAL DATA SHEET

Product: Un-Plasticized Poly Vinyl Chloride (uPVC/Rigid PVC) Profiles

Properties	Typical Values
Specific Gravity	$\geq 1.39 \pm 0.02$
Hardness (Shore – D)	76 ± 1
Tensile Strength	$\geq 41 \pm 2 \text{ N/mm}^2$
Elongation at Break	$\geq 151\%$
Modulus of Elasticity	2670 MPa
Softening Temperature (Vicat Softening Point)	$\geq 76 \text{ }^\circ\text{C}$
Thermal Expansion	78 $\mu\text{m/m-K}$
U-Value	1.00 – 1.20
Dimensional Stability	0.1289 %
Impact Resistance	202.5 J

Our uPVC / Rigid PVC Profiles offer these unique advantages:

- ❖ Variety of Colors
- ❖ Excellent Mechanical Properties
- ❖ Smooth and Homogenous Surface Finish
- ❖ Excellent Processability
- ❖ Excellent Impact Resistance
- ❖ Excellent UV- and Weather Resistance
- ❖ Excellent Flame Retardancy
- ❖ 100% Lead Free
- ❖ 100% Plasticizer Free

Reliance Rubber and Plastic Industries L.L.C manufacture the highest quality products in-line with the latest Industry trends.

All our products are 100% Lead free, Eco-friendly & ROHS Compliant.

ISOLATOR

RP-5027

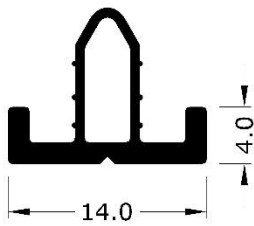

RP-5008

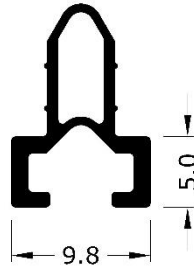

RP-5049

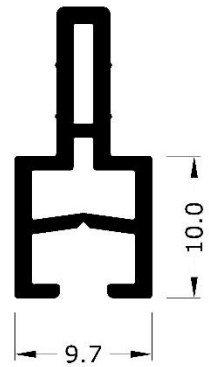

RP-5013

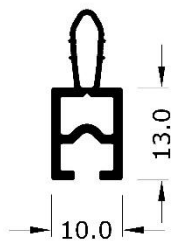

RP-5006

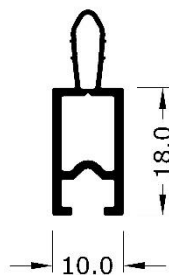

RP-5024

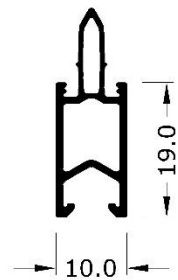

RP-5009

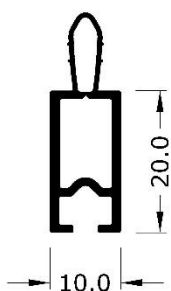

RP-5026

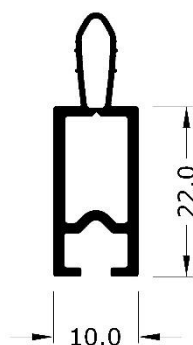

RP-5017

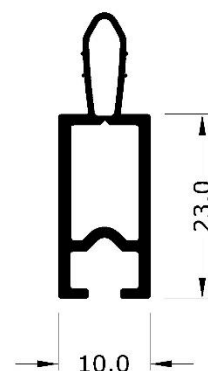

RP-5001

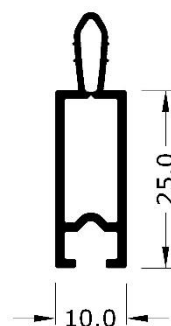

RP-5003

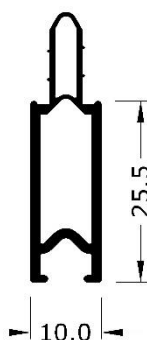

RP-5025

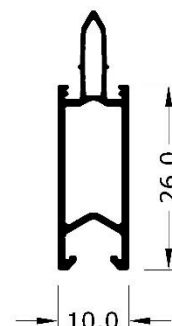

RP-5020

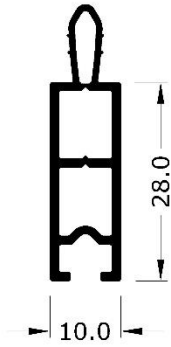

RP-5022

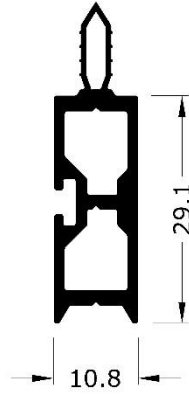

RP-5028

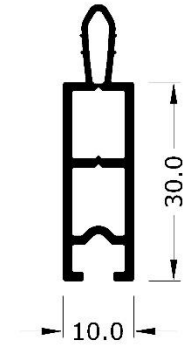

RP-5004

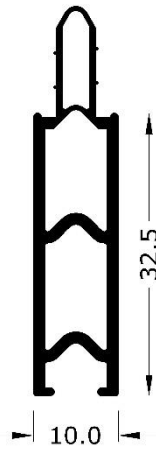

RP-5021

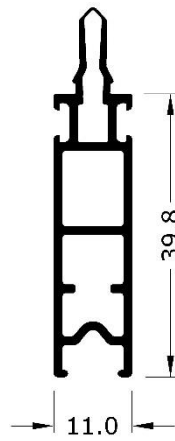

RP-5037

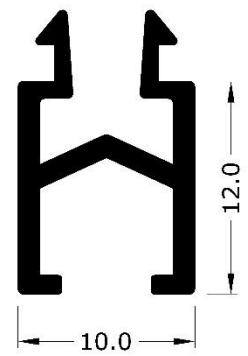

RP-5015

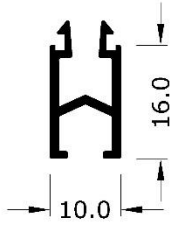

RP-5019

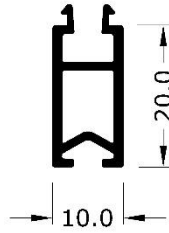

RP-5010

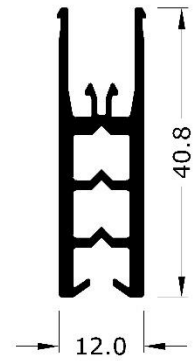

RP-5011

